

PRODUCT OVERVIEW.

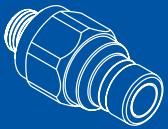

Mono-Couplings.

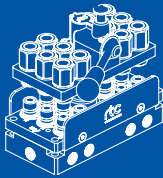

Multi-Couplings.

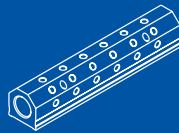

Manifolds.

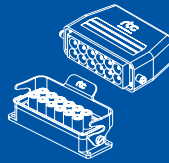

Mini-Con.



Electrical-Connectors.

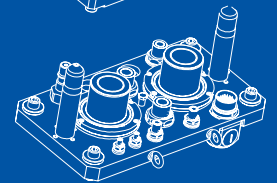
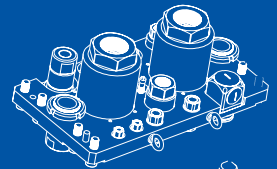

Customized Solutions.



Accessories.

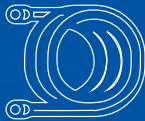

Hoses.

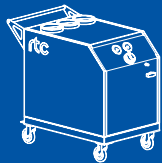

Mold Cleaner.



Flow Regulators.



Huracan.

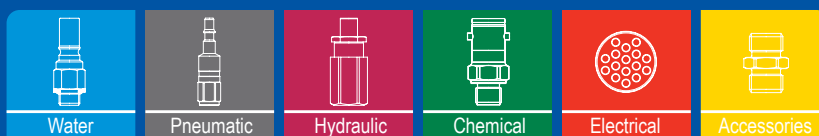

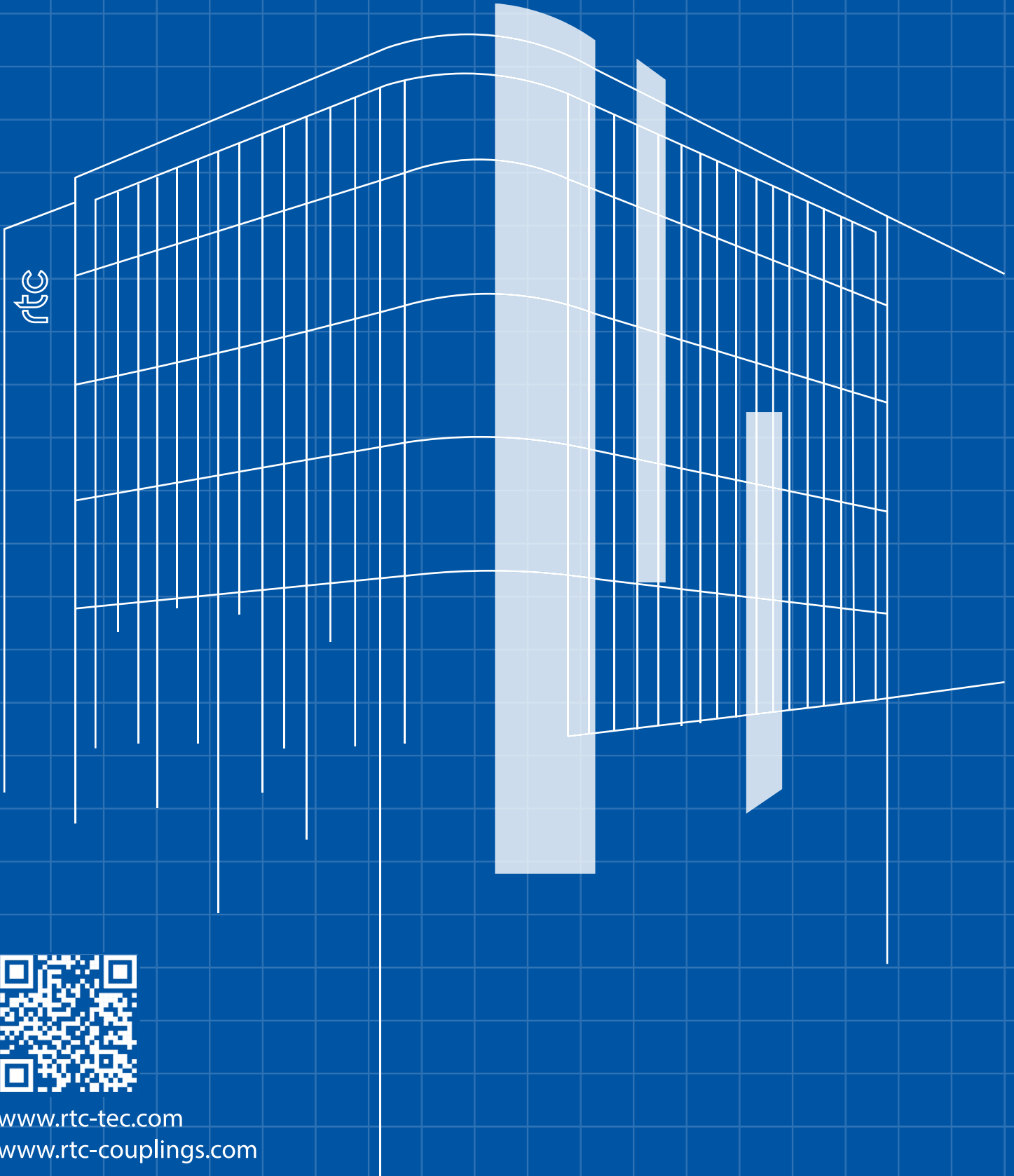

WHO
WE ARE.

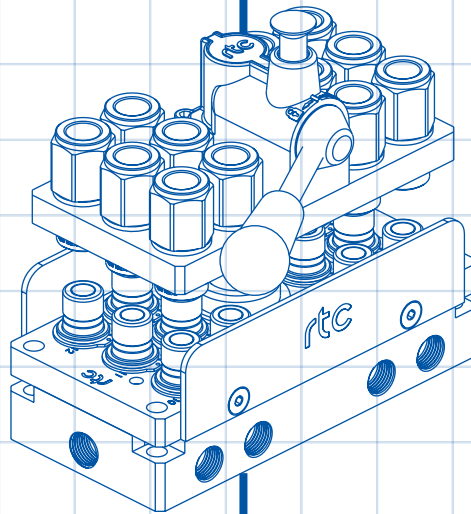

WER
WIR SIND.

rtc Coupling Technology

Reliable - Innovative - Passionate

Coupling system is our passion.

rtc Couplings is specialised in designing, developing and manufacturing quick release couplings for a breadth of industries.

rtc stands out as a leading brand in the quick couplings sector, boasting extensive market presence and global recognition. Our purpose is to advance any industrial process to cost efficient, safe and sustainable operation.

rtc delivers coupling, multicoupling and docking systems for water, pneumatic, hydraulic, chemical and electrical connections. We offer a complete range of more than 15,000 different products.

rtc couplings are produced based on highest safety standards with many own designed and compatible profiles to common manufacturers in all industries.

We have a direct line to our clients and a firsthand understanding of what they really need. In order to ensure a continuous process of improvement, we are developing new products together with our clients by analyzing all their inquiries and requirements.

Right now, we are exporting almost 95% of our products to more than 60 countries in 6 different continents backed by our sales offices, partners and technical support teams. We are proud of being your choice for intelligent and sustainable quick coupling solutions.

We are ready for any challenges!

WE ARE **rtc!**

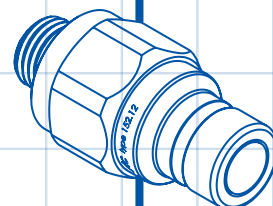

rtc Coupling Technology

Zuverlässig - Innovativ - Leidenschaftlich

Kupplungssysteme sind unsere Leidenschaft.

rtc Couplings ist auf die Entwicklung, Konstruktion und die Herstellung von Schnellverschlusskupplungen für zahlreiche Branchen spezialisiert. rtc ist eine führende Marke im Bereich der Schnellverschlusskupplungen und verfügt über umfassende Marktpräsenz und weltweite Anerkennung. Unser Ziel ist es, jeden industriellen Prozess so zu optimieren, dass er kosteneffizient, sicher und nachhaltig funktioniert.

rtc liefert Ihnen alle Kupplungs-, Multikupplungs- und Verbindungssysteme für Wasser-, Pneumatik-, Hydraulik-, Chemie- und für Elektronikanwendungen. Wir bieten Ihnen ein komplettes Sortiment mit über 15.000 verschiedenen Artikeln.

Die Produkte von rtc werden auf Basis höchster Sicherheitsstandards hergestellt. Bei uns können Sie wählen, zwischen unseren selbst entwickelten Kupplungsprofilen oder den gängigen Profilen und deren Kompatibilität zu den jeweiligen Herstellern aus allen Industriezweigen.

Wir haben einen direkten Draht zu unseren Kunden und wissen aus erster Hand, was Sie wirklich brauchen. Um einen kontinuierlichen Verbesserungsprozess zu gewährleisten, entwickeln wir gemeinsam mit unseren Kunden neue Produkte, indem wir alle Ihre Anfragen und Anforderungen analysieren.

Derzeit exportieren wir ca. 95 % unserer Produkte in über 60 Länder auf 6 verschiedenen Kontinenten, unterstützt durch unsere Vertriebsbüros, Partner und technischen Supportteams. Wir sind stolz darauf, Ihre Wahl für intelligente und nachhaltige Schnellkupplungslösungen zu sein.

Wir sind für jede Herausforderung bereit!

WIR SIND **rtc!**

rtc TYPE 090
European Profile

Water

PATENTED DESIGN with AUTOMATIC Safety Locking Sleeve



DN 6 mm - 9 mm - 13 mm

16 bar - 232 PSI

FPM (V) -10°C +180°C (+14°F +356°F)
EPDM (E) -40°C +150°C (-40°F +302°F)
High Temp (HT) -20°C +230°C (-4°F +446°F)

- Standard version**
- Brass
- Seals FPM (V)
- Option**
- Stainless Steel
- Patented Automatic Safety Release Sleeve
- Colour coding (Red, Blue, ...)

rtc TYPE 099
International Profile

Water

SAFETY TYPE FOR DISCONNECT PROTECTION



dn 6 mm - 9 mm - 15 mm

16 bar - 232 PSI

FPM (V) -10°C +180°C (+14°F +356°F)
Silicone (SN) -40°C +175°C (-40°F +347°F)

- Standard version**
- Brass
- Seals FPM (V)
- Option**
- Stainless Steel
- Safety lock
- Colour coding (Red, Blue, ...)

rtc TYPE 100
French Profile

Water

SAFETY TYPE FOR DISCONNECT PROTECTION



dn 6 mm - 8 mm - 12 mm

10 bar - 145 PSI

NBR (N) -20°C +100°C (-4°F +212°F)
FPM (V) -10°C +180°C (+14°F +356°F)
High Temp (HT) -20°C +230°C (-4°F +446°F)

- Standard version**
- Brass Nickel Plated
- Seals NBR (N)
- Option**
- Safety Sleeve
- Colour coding (Red, Blue)

rtc TYPE 101

Water



dn 6 mm - 9 mm - 10 mm - 12 mm
16 mm - 20 mm - 25 mm - 32 mm
37 mm - 38 mm

16 bar - 232 PSI

NBR (N) -20°C +100°C (-4°F +212°F)
FPM (V) -10°C +180°C (+14°F +356°F)
EPDM (E) -40°C +150°C (-40°F +302°F)
High Temp (HT) -20°C +230°C (-4°F +446°F)

- Standard version**
- Stainless Steel and Brass
- Seals FPM (V)
- Option**
- Stainless Steel
- Colour coding (Red, Blue)
- Safety Sleeve
- Dust Cap



dn 3 mm - 6 mm - **7 mm** - **8 mm**
9 mm - 12 mm - 16 mm - 25 mm

50 bar - 725 PSI

NBR (N) -20°C +100°C (-4°F +212°F)
FPM (V) -10°C +180°C (+14°F +356°F)
FFKM (W) 0°C +250°C (+32°F +482°F)
EPDM (E) -40°C +150°C (-40°F +302°F)

Standard version
Stainless Steel and Brass
Seals FPM (V)
Advantages
Flat Faced Non-Spill
One Hand Push & Pull Connection
Option
- Stainless Steel
- Colour coding

Water

rtc TYPE 102
Flatface for Blow Moulding



*New Design / *Neues Design



dn 4 mm - 6 mm - 10 mm - 13 mm - 19 mm
25 mm - 32 mm - 38 mm

85 - 360 bar (1.250 - 5.200 PSI) - Brass
140 - 520 bar (2.000 - 7.500 PSI) - Steel
120 - 465 bar (1.750 - 6.700 PSI) - Stainless Steel

NBR (N) -20°C +100°C (-4°F +212°F)
FPM (V) -10°C +180°C (+14°F +356°F)
EPDM (E) -40°C +150°C (-40°F +302°F)

Standard version
Brass
Seals NBR (N)
Advantages
Full flow
Option
- Stainless Steel
- Steel Zinc Plated
- Colour coding

Compatible Parker ST

Water

Pneumatic

Hydraulic

rtc TYPE 045
Full Flow



dn 4 mm - 8 mm - 10 mm - 13 mm - 16 mm
19 mm - 32 mm - 38 mm - 50 mm

50 - 210 bar (725 - 3.045 PSI) - Brass
100 - 300 bar (1.450 - 4.350 PSI) - Stainless Steel

NBR (N) -20°C +100°C (-4°F +212°F)
FPM (V) -10°C +180°C (+14°F +356°F)

Standard version
Brass
Seals NBR (N)
Option
- Stainless Steel

Compatible
ISO 7241-1 Serie B

Water

Pneumatic

Hydraulic

rtc TYPE 070
ISO 7241-1 SERIE B



dn 3 mm - 6 mm - 8 mm - 10 mm - 12 mm
13 mm - 16 mm - 20 mm - 25 mm - 32 mm
38 mm - 50 mm

16 bar - 60 bar (232 PSI - 870 PSI)

FPM (V) -10°C +180°C (+14°F +356°F)
EPDM (E) -40°C +150°C (-40°F +302°F)
High Temp (HT) -20°C +230°C (-4°F +446°F)
FFKM (W) 0°C +250°C (+32°F +482°F)

Standard version
Stainless Steel and Brass
Seals FPM (V)
Advantages
Flat Faced Non-Spill
High Flow Rate Valve Design
Option
- Full Stainless Steel
- Aluminium
- Panel Mounting
- Colour coding (Red, Blue)

Water

Pneumatic



rtc TYPE 152
Flatface Non-Spill
RTC Profile



rtc TYPE 105 Dripless Valve

Water



dn 9 mm - 12 mm - 16 mm - 20 mm - 25 mm

i **Standard version**
Brass Chrome Plated & Stainless Steel
Seals FPM (V)
Advantage
Suitable for outdoor applications
Option
- Colour coding

16 bar - 232 PSI

Temperature Range:
NBR (N) -20°C +100°C (-4°F +212°F)
FPM (V) -10°C +180°C (+14°F +356°F)
EPDM (E) -40°C +150°C (-40°F +302°F)
FFKM (W) 0°C +250°C (+32°F +482°F)
FMQ (FSN) -50°C +175°C (-58°F +347°F)

rtc TYPE 106 Full Flow & Valved

Water

New Design
with Valve



dn 19 mm - 25 mm - 33 mm - 42 mm
50 mm - 63 mm - 110 mm

i **Standard version**
Brass Chrome Plated & Stainless Steel
Seals NBR (N)
Option
- Safety Sleeve
- Colour coding
- Double Shut-off (Valved Design)

10 bar - 145 PSI

Temperature Range:
NBR (N) -20°C +100°C (-4°F +212°F)
FPM (V) -10°C +180°C (+14°F +356°F)
EPDM (E) -40°C +150°C (-40°F +302°F)

*New Flow Sizes / *Neues Durchflussgröße

rtc TYPE 162 High Flow - One Hand Connection RTC Profile

Water

High
Flow Rate

New
Design



dn 16 mm - 20 mm - 25 mm - 32 mm
38 mm - 50 mm

i **Standard version**
Stainless Steel and Brass
Seals FPM (V)
Advantages
Flat Faced Non-Spill
Compact Design
High Flow Rate Valve Design
Option
- Full Stainless Steel
- Aluminium
- Colour coding
- Panel mounting

16 bar - 60 bar (232 PSI - 870 PSI)

Temperature Range:
NBR (N) -20°C +100°C (-4°F +212°F)
FPM (V) -10°C +180°C (+14°F +356°F)
EPDM (E) -40°C +150°C (-40°F +302°F)
FFKM (W) 0°C +250°C (+32°F +482°F)

rtc TYPE 131 Light Weight

Water



dn 5 mm - 8 mm - 10 mm - 12 mm
17 mm - 20 mm - 25 mm

i **Standard version**
Aluminium
Seals NBR (N)
Advantages
Flat Faced Non-Spill
High Flow Rate Valve Design
Option
- Colour coding

16 - 40 bar (232 - 580 PSI) - -40°C +150°C
5 - 13 bar (73 - 190 PSI) - +150°C +200°C

Temperature Range:
NBR (N) -20°C +100°C (-4°F +212°F)
FPM (V) -10°C +180°C (+14°F +356°F)
EPDM (E) -40°C +150°C (-40°F +302°F)
FMQ (FSN) -50°C +175°C (-58°F +347°F)



dn 8 mm

20 bar - 290 PSI

NBR (N) -20°C +100°C (-4°F +212°F)
 FPM (V) -10°C +180°C (+14°F +356°F)
 FFKM (W) 0°C +250°C (+32°F +482°F)

i Standard version
 Stainless Steel and Brass
 Seals FPM (V)
Advantage
 Robotic Applications
 Mould cooling
 Blow moulding
 Docking System

Compatible
 Hasco Z 809
 Hasco Z 819

Water

rtc TYPE 093



dn 6 mm - 8 mm - 12 mm

16 - 20 bar (232 - 290 PSI) - Brass
 100 bar (1450 PSI) - Stainless Steel

NBR (N) -20°C +100°C (-4°F +212°F)
 FPM (V) -10°C +180°C (+14°F +356°F)

i Standard version
 097 - Stainless Steel & Brass
 098 - Brass
 Seals FPM (V)
Advantage
 Compact design suitable for
 Robotic Applications
Option
 - Aluminium
 - Stainless Steel

Water

Pneumatic

rtc TYPE 097
 For Robotic Connection



Water

Pneumatic

rtc TYPE 098
 For Robotic Connection



dn 6 mm - 8 mm - 11 mm - 19 mm - 25 mm

16 - 50 bar (232 - 725 PSI) - Standard
 300 - 450 bar (4350 - 6.500 PSI) - Stainless Steel

NBR (N) -20°C +100°C (-4°F +212°F)
 FPM (V) -10°C +180°C (+14°F +356°F)

i Standard version
 Stainless Steel and Steel
 Seals FPM (V)
Advantage
 For automatic multi-connections
 Docking system
 One steam line
Option
 - Brass Nickel Plated

Compatible
 Cejn 925

Water

Hydraulic

rtc TYPE 155
 Flatface for docking systems



dn 3 mm - 6 mm - 8 mm - 11 mm - 16 mm - 19 mm

16 - 50 bar (232 - 725 PSI) - Standard
 300 - 450 bar (4.350 - 6.500 PSI) - Stainless Steel

NBR (N) -20°C +100°C (-4°F +212°F)
 FPM (V) -10°C +180°C (+14°F +356°F)
 EPDM (E) -40°C +150°C (-40°F +302°F)
 FFKM (W) 0°C +250°C (+32°F +482°F)
 FMQ (FSN) -50°C +175°C (-58°F +347°F)

i Standard version
 Stainless Steel and Steel
 Seals NBR (N)
Advantage
 For automatic multi-connections
 Docking system
 One steam line
Option
 - Full Stainless Steel

Water

Pneumatic

Hydraulic

rtc TYPE 173
 For Multi plates



rtc TYPE 103 Flatface & Under Pressure Connection

Hydraulic



*New Design / *Neues Design

rtc TYPE 124 Flatface & Under Pressure Connection

Hydraulic



rtc TYPE 170 ISO 6150-C

Water Pneumatic Hydraulic



*New Design / *Neues Design

rtc TYPE 108

Hydraulic



*New Design / *Neues Design



dn

dn	bar	PSI
6 mm	800	11.600
7 mm	500	7.250
8 mm	450	6.525
11 mm	450	6.525
12 mm	400	5.800
16 mm	400	5.800
19 mm	400	5.800
25 mm	350	5.075
33 mm	350	5.075



bar PSI



- Standard version
Stainless Steel and Steel
Seals FPM (V)
Option
- Colour coding (Red, Blue)
- Residual Pressure Release
valve for Connecting Under Pres-
sure (**150 bar**)
- Dust Cap
- Panel Mounting



NBR (N) -20°C +100°C (-4°F +212°F)
FPM (V) -10°C +180°C (+14°F +356°F)



dn

dn	bar	PSI
6 mm	450	6.525
8 mm	450	6.525
9 mm	350	5.075
12 mm	350	5.075
16 mm	350	5.075



bar PSI



- Standard version
Stainless Steel and Steel
Seals FPM (V)
Option
- Colour coding (Red, Blue)
- Residual Pressure Release
valve for Connecting Under Pres-
sure (**150 bar**)
- Dust Cap
- Panel Mounting



NBR (N) -20°C +100°C (-4°F +212°F)
FPM (V) -10°C +180°C (+14°F +356°F)



dn

3 mm - 6 mm - 7 mm - 8 mm - 9 mm
10 mm 11 mm - 12 mm - 13 mm
14 mm - 16 mm - 19 mm



50 - 210 bar (725 - 3.045 PSI) - Standard Version
300 - 450 bar (4.350 - 6.525 PSI) - High Pressure



NBR (N) -20°C +100°C (-4°F +212°F)
FPM (V) -10°C +180°C (+14°F +356°F)
EPDM (E) -40°C +150°C (-40°F +302°F)
FFKM (W) 0°C +250°C (+32°F +482°F)
FMQ (FSN) -50°C +175°C (- 58°F +347°F)



- Standard version
Stainless Steel and Steel
Seals NBR (N)
Option
- Safety lock
- Vacuum
- Dust Cap Fixing Ring
- Dust Cap
- Raised Button
- Safety Button
- Colour Coding
- Stainless Steel (Full)



Compatible
ISO 6150-C



dn

dn	bar	PSI
3 mm	250	3625
6 mm	180	3625
7 mm	180	3625
9 mm	180	3625
12 mm	180	3625
16 mm	180	3625



bar PSI



- Standard version
Stainless Steel
Seals FPM (V)
Advantages
Flat Faced Non-Spill
One Hand Push & Pull Connection
Option
- Colour coding
- Two hand connection
- Residual Pressure Release valve
for Connecting Under Pressure
(**150 bar**)



NBR (N) -20°C +100°C (-4°F +212°F)
FPM (V) -10°C +180°C (+14°F +356°F)
EPDM (E) -40°C +150°C (-40°F +302°F)
FFKM (W) 0°C +250°C (+32°F +482°F)
FMQ (FSN) -50°C +175°C (- 58°F +347°F)



dn

5 mm
6 mm
10 mm
12 mm
16 mm
19 mm
25 mm
37 mm

bar PSI

400 - 5800
400 - 5800
375 - 5450
350 - 5075
350 - 5075
300 - 4350
250 - 3625
200 - 2900

i

Standard version
Steel with Black Oxide Plating
Seal NBR (N)

Option
- Colour coding (Red, Blue)
- Panel Mounting

Compatible

ISO 16028

Temperature

NBR (N) -20°C +100°C (-4°F +212°F)
FPM (V) -10°C +180°C (+14°F +356°F)

Hydraulic

Safety Sleeve

rtc TYPE 072
ISO 16028



dn

4 mm
6 mm
8 mm
10 mm
12 mm
15 mm
20 mm
25 mm
32 mm
37 mm
50 mm
75 mm
100 mm

Standard

bar PSI
160 - 2320
160 - 2320
160 - 2320
160 - 2320
160 - 2320
160 - 2320
160 - 2320
160 - 2320
100 - 1450
16 - 232
16 - 232
10 - 145
10 - 145

High Pressure

bar PSI
500 - 7.250
500 - 7.250
500 - 7.250
250 - 3.625
250 - 3.625
250 - 3.625
250 - 3.625
250 - 3.625

i

Standard version
Stainless Steel
Seal FPM (V)

Option
- High Pressure Stainless Steel

Temperature

NBR (N) -20°C +100°C (-4°F +212°F)
FPM (V) -10°C +180°C (+14°F +356°F)
EPDM (E) -40°C +150°C (-40°F +302°F)

Hydraulic

rtc TYPE 104
Flatface for docking systems



dn

3 mm
5 mm
8 mm
12 mm
20 mm
28 mm

bar PSI

450 - 3625
300 - 3625
250 - 3625
160 - 3625
160 - 3625
160 - 3625

i

Standard
Stainless Steel
Seal FPM (V)

Temperature

NBR (N) -20°C +100°C (-4°F +212°F)
FPM (V) -10°C +180°C (+14°F +356°F)
EPDM (E) -40°C +150°C (-40°F +302°F)

Hydraulic

rtc TYPE 115
Flatface for docking systems



dn

8 mm
12 mm
16 mm
20 mm
25 mm
33 mm

bar PSI

500 - 7250
500 - 7250
500 - 7250
500 - 7250
500 - 7250
350 - 5075

i

Standard version
Stainless Steel and Steel
Seal FPM (V)

Option
- Dust Cap
- Panel Mounting
- Hand Wheel

Temperature

NBR (N) -20°C +100°C (-4°F +212°F)
FPM (V) -10°C +180°C (+14°F +356°F)
FFKM (W) 0°C +250°C (+32°F +482°F)



Hydraulic

rtc TYPE 126
Heavy Vibration Applications



rtc TYPE 200
Low Pressure

Water Pneumatic Hydraulic



dn 3 mm - 4 mm - 6 mm - 7 mm - 9 mm - 12 mm
19 mm - 32 mm - 50 mm

i Standard version
Brass
Seal NBR (N)
Option
- Brass Nickel Plating
- Steel Zinc Plating
- Stainless Steel

Pressure 20-200 bar (290 - 2.900 PSI) - Brass
20-200 bar (290 - 2.900 PSI) - Stainless Steel
30-100 bar (435 - 1.450 PSI) - Steel

Compatible
Walther LP Type
Walther SP Type

Temperature NBR (N) -20°C +100°C (-4°F +212°F)
FPM (V) -10°C +180°C (+14°F +356°F)

rtc TYPE 201
Medium Pressure

Hydraulic



dn 6 mm - 7 mm - 12 mm - 19 mm - 25 mm
32 mm - 50 mm

i Standard version
Steel Zinc Plated
Seal NBR (N)
Option
- Brass Nickel Plating
- Stainless Steel
- Chromium Plating

Pressure 30-40 bar (435 - 580 PSI) - Brass
30-100 bar (435 - 1450 PSI) - Stainless Steel
100-250 bar (1.450 - 3.635 PSI) - Steel

Compatible
Walther MD Type

Temperature NBR (N) -20°C +100°C (-4°F +212°F)
FPM (V) -10°C +180°C (+14°F +356°F)

rtc TYPE 202
High Pressure

Hydraulic

High Pressure



dn 4 mm - 6 mm - 10 mm - 16 mm
20 mm - 32 mm - 50 mm

i Standard version
Steel oil burnished
Seal NBR (N)

Pressure 200 - 2.000 bar (2.900 - 2.9000 PSI) - Steel
180 - 500 bar (2.610 - 7.250 PSI) - Stainless Steel
250 - 1.000 bar (3625 - 14.500 PSI) - High Pressure SS

Compatible
Walther HP Type

Temperature NBR (N) -20°C +100°C (-4°F +212°F)
FPM (V) -10°C +180°C (+14°F +356°F)

rtc TYPE 208
Flatface Dry Break

Hydraulic

New Design



dn	bar	PSI
6 mm	650	9.500
8 mm	600	8.700
12 mm	600	8.700
16 mm	600	8.700
20 mm	600	8.700

i Standard version
Steel with Zinc Plating
Seal NBR (N)

Compatible
Walther HC Type

Temperature NBR (N) -20°C +100°C (-4°F +212°F)
FPM (V) -10°C +180°C (+14°F +356°F)



Hydraulic Chemical

rtc TYPE 074
ISO 16028

dn

6 mm
10 mm
13 mm
16 mm
19 mm
25 mm
32 mm
37 mm

bar PSI

210 - 3.045
210 - 3.045
210 - 3.045
210 - 3.045
210 - 3.045
210 - 3.045
180 - 2.610
180 - 2.610



Standard version
Stainless Steel
Seal NBR (N)
Advantages
High Flow
Heavy Duty
Hardened Special Steel Body



Compatible
Nitto Kohki HSP



NBR (N) -20°C +100°C (-4°F +212°F)
FPM (V) -10°C +180°C (+14°F +356°F)



Hydraulic

rtc TYPE 076
ISO 7241-A

dn

6 mm
10 mm
13 mm
16 mm
19 mm
25 mm
32 mm

bar PSI

315 - 4.570
315 - 4.570
250 - 3.625
200 - 2.900
200 - 2.900
200 - 2.900
200 - 2.900



Standard version
Steel Zinc Plated
Seal NBR (N)



Compatible
ISO 7241-A



NBR (N) -20°C +100°C (-4°F +212°F)
FPM (V) -10°C +180°C (+14°F +356°F)



Hydraulic

rtc TYPE 089

dn

5 mm - 6 mm - 10 mm - 13 mm
19 mm - 25 mm - 35 mm - 45 mm



25 - 50 bar (360 - 725 PSI) - Brass
180 - 450 bar (2600 - 6525 PSI) - Steel
120 - 300 bar (1750 - 4350 PSI) - Stainless Steel



Standard version
Steel and Brass
Seal NBR (N)
Advantages
Low Pressure Drop
Maximum Flow Capacity
Safety Locking Sleeve
Option
- Pressure Release Valve
- Safety Sleeve



Compatible
Parker-Tema T



NBR (N) -20°C +100°C (-4°F +212°F)
FPM (V) -10°C +180°C (+14°F +356°F)



Hydraulic

rtc TYPE 245

dn

6 mm
12 mm
19 mm

bar PSI

410 - 5.950
410 - 5.950
310 - 4.500



Standard version
Steel Zinc Plated
Seal NBR (N)



Compatible
Parker SM



NBR (N) -20°C +100°C (-4°F +212°F)
FPM (V) -10°C +180°C (+14°F +356°F)



rtc TYPE 116 High Temperature

Water Chemical Hydraulic



New Design
for Ultra High
Temperature
with Additional
Safety

dn 9 mm - 12 mm - 16 mm - 20 mm

25 bar - 362 PSI

FPM (V) -10°C +180°C (+14°F +356°F)
FFKM (W) 0°C +325°C (+32°F +617°F)

i Standard version
Stainless Steel
Seals FFKM (W)
Advantages
Safety lock
High Temperature applications
Easy to change and maintenance seal
Push to disconnect
Option
- Colour coding (Red, Blue)



rtc TYPE 123 Bayonet Connection

Chemical Hydraulic



dn	bar PSI
3 mm	500 - 5.075
5 mm	250 - 2.320
8 mm	10 - 1.160
12 mm	50 - 725
16 mm	50 - 725
20 mm	50 - 725

NBR (N) -20°C +100°C (-4°F +212°F)
FPM (V) -10°C +180°C (+14°F +356°F)
EPDM (E) -40°C +150°C (-40°F +302°F)
FFKM (W) 0°C +250°C (+32°F +482°F)
FMQ (FSN) -50°C +175°C (-58°F +347°F)

i Standard version
Stainless Steel 316L
Seals NBR (N)
Option
- Dust Cap
- Colour coding (Red, Blue)
- Panel Mounting



rtc TYPE 203 High Temperature

Chemical Hydraulic



dn 9 mm - 12 mm - 19 mm - 32 mm - 50 mm

10 - 50 bar (145 - 725 PSI) - Brass
10 - 50 bar (145 - 725 PSI) - Stainless Steel
30 - 100 bar (435 - 1450 PSI) - Steel

FPM (V) -10°C +180°C (+14°F +356°F)
PTFE (PT) -50°C +250°C (-58°F +482°F)

i Standard version
Stainless Steel 316L
Seals FPM (V)

Compatible
Walther TE Type



rtc TYPE 205 Chemical Usage

Chemical Hydraulic



dn	bar PSI
5 mm	64 - 930
7 mm	64 - 930
9 mm	64 - 930
12 mm	64 - 930
19 mm	40 - 580

FPM (V) -10°C +180°C (+14°F +356°F)
EPDM (E) -40°C +150°C (-40°F +302°F)
FFKM (W) 0°C +250°C (+32°F +482°F)

i Standard version
Stainless Steel
Seals FPM (V)

Compatible
Walther CT Type





dn 12 mm - 19 mm - 25 mm

Pressure 16 bar - 230 PSI

Temperature
FPM (V) -10°C +180°C (+14°F +356°F)
FFKM (W) 0°C +325°C (+32°F +617°F)

Info Standard version
Steel black oxide
Seals FFKM (W)
Using Area
For Hot Oil Usages
Option
Special Patented Safety Sleeve

Compatible
Walther 11 Type

Hydraulic



Ultra High Temperature



rtc TYPE 219
High Temperature

Patented Design
AUTOMATIC Safety
Locking



dn	bar	PSI
25 mm	25 - 360	
40 mm	25 - 360	
50 mm	25 - 360	
80 mm	16 - 230	
100 mm	10 - 145	

Info Standard version
Stainless Steel 316L
Seals FPM (V)
Option
- Handwheel
- Flansch
- Mechanical Coding
- Colour Coding

Compatible
Walther CN Type

Hydraulic

Chemical



New Design

rtc TYPE 207
Loading & Filling



Temperature
NBR (N) -20°C +100°C (-4°F +212°F)
FPM (V) -10°C +180°C (+14°F +356°F)



dn 5 mm

Info Standard version
Steel zinc plated
Seals NBR (N)
Option
- Stainless Steel

Pressure 170 bar - 2.500 PSI

Compatible
Walther FF-005 Type
Walther 15-005 Type

Temperature
NBR (N) -20°C +100°C (-4°F +212°F)
FPM (V) -10°C +180°C (+14°F +356°F)

Hydraulic

Chemical

rtc TYPE 215
Clean Break



dn 6 mm - 9 mm - 13 mm - 19 mm - 25 mm
30 mm - 38 mm

Info Standard version
Steel Zinc Plated
Advantages
High Flow
Flat Face
Heavy Duty
Option
- Stainless Steel

Pressure
515 - 690 bar (7.500 - 10.000 PSI) - High Pressure Stainless Steel
275 - 345 bar (4.000 - 5.000 PSI) - Stainless Steel
515-690 bar (7.500 - 10000 PSI) - Steel

Compatible
Parker-Snap Tite 71 Type

Hydraulic

Chemical

rtc TYPE 071



Temperature
NBR (N) -20°C +100°C (-4°F +212°F)
FPM (V) -10°C +180°C (+14°F +356°F)

rtc TYPE 080
Ultimate High Pressure

Hydraulic



dn 4 mm

1.000 bar - 14.500 PSI

NBR (N) -20°C +100°C (-4°F +212°F)

- i** **Advantages**
- Ultimate High Pressure (UHP) dripless hydraulic coupling.
 - Plug and Coupler has plastic dust cap in order to increase the service life.
 - Aluminium Dust cap is also available.
 - Uninterchangeable sister coupling is also available in order to avoid any mis-connection. (rtc 082.04)

Compatible
Cejn 115

rtc TYPE 081
Ultimate High Pressure

Hydraulic



dn 3 mm

1.500 bar - 21.755 PSI

NBR (N) -20°C +100°C (-4°F +212°F)

- i** **Advantages**
- Ultimate High Pressure (UHP) dripless hydraulic coupling.
 - Plug and Coupler has plastic dust cap in order to increase the service life.
 - Aluminium Dust cap is also available.

Compatible
Cejn 116

rtc TYPE 083
Ultimate High Pressure

Hydraulic



dn 3 mm

2.000 bar - 29.000 PSI

NBR (N) -20°C +100°C (-4°F +212°F)

- i** **Advantages**
- Ultimate High Pressure (UHP) dripless hydraulic coupling.
 - Plug and Coupler has plastic dust cap in order to increase the service life.
 - Aluminium Dust cap is also available.

Compatible
Cejn 125

rtc TYPE 043

Water Pneumatic



dn 12 mm - 19 mm

15 bar - 215 PSI

NBR (N) -20°C +100°C (-4°F +212°F)
FPM (V) -10°C +180°C (+14°F +356°F)

i **Standard version**
Brass
Seals NBR (N)

Compatible
Legris 8500L



Water

rtc TYPE 042

dn 11 mm - 16 mm

i Standard version
Seals FPM (V)
Option
- Safety lock
- Stainless Steel

35 bar - 510 PSI

Compatible
Parker 42
ABA

Temperature:
NBR (N) -20°C +100°C (-4°F +212°F)
FPM (V) -10°C +180°C (+14°F +356°F)
EPDM (E) -40°C +150°C (-40°F +302°F)



Water

Pneumatic

rtc TYPE 044

dn 11 mm - 16 mm - 19 mm

i Standard version
Brass Nickel Plated
Seals NBR (N)
Option
- Stainless Steel

15 bar - 215 PSI

Temperature:
NBR (N) -20°C +100°C (-4°F +212°F)
FPM (V) -10°C +180°C (+14°F +356°F)



Water

Pneumatic

Hydraulic

rtc TYPE 046

dn 6 mm - 9 mm - 13 mm - 19 mm - 25 mm
25 mm - 30 mm - 38 mm - 50 mm

i Standard version
Seals NBR (N)
Option
- Stainless Steel
- Steel Zinc Plated
- Brass

Pressure:
155 - 450 bar (400 - 2.250 PSI) - Brass
100 - 450 bar (1500 - 6.500 PSI) - Steel
35 - 350 bar (500 - 5.000 PSI) - Stainless Steel
20 - 155 bar (300 - 2.250 PSI) - Aluminium

Compatible
Snap Tite H

Temperature:
NBR (N) -20°C +100°C (-4°F +212°F)
FPM (V) -10°C +180°C (+14°F +356°F)



Water

Pneumatic

Hydraulic

rtc TYPE 053

dn 6 mm - 10 mm - 13 mm - 19 mm - 25 mm
32 mm - 38 mm - 50 mm

i Standard version
Seals NBR (N)
Option
- Stainless Steel
- Steel Zinc Plated
- Brass

Pressure:
15 - 50 bar (218 - 725 PSI) - Brass (MS)
20 - 75 bar (290 - 1090 PSI) - Steel (ST)

Compatible
Nitto Kohki TSP

Temperature:
NBR (N) -20°C +100°C (-4°F +212°F)
FPM (V) -10°C +180°C (+14°F +356°F)



rtc TYPE 460 & 469

Pneumatic



dn 3 mm - 6 mm - 8 mm - 11 mm - 19 mm

- i** **Advantage**
Self Venting Safety Type
- The system perfectly fits to the **ISO 4414, EN 983** safety Standards.
 - Full flow, negligible loss of pressure
 - Simple operation, no force required
 - Compact design
 - Almost all plug profiles are available in Pneumatic Industry.

25 bar (365 PSI)
15 bar (220 PSI) Connection / Disconnection

NBR (N) -20°C +100°C (-4°F +212°F)
FPM (V) -10°C +180°C (+14°F +356°F)

rtc TYPE 450

ISO 6150-C

Pneumatic



dn 3 mm - 6 mm - 8 mm - 11 mm

- i** **Advantage**
Self Venting Safety Type
- The system perfectly fits to the **ISO 4414, EN 983** safety Standards requirements.
 - Model to ISO 6150-C-10 and AFNOR: C-10 NF E 49-053
 - Safety feature: 2-stage disconnection

25 bar (365 PSI)
15 bar (220 PSI) Connection / Disconnection

NBR (N) -20°C +100°C (-4°F +212°F)
FPM (V) -10°C +180°C (+14°F +356°F)
EPDM (E) -40°C +150°C (-40°F +302°F)

Compatible
ISO 6150-C

rtc TYPE 451

ISO 6150-C

Pneumatic



dn 6 mm - 8 mm

- i** **Advantage**
Self Venting Safety Type
- The system perfectly fits to the **ISO 4414, EN 983** safety Standards requirements.
 - Model to ISO 6150-C-10 and AFNOR: C-10 NF E 49-053
 - Safety feature: 2-stage disconnection

25 bar (365 PSI)
15 bar (220 PSI) Connection / Disconnection

NBR (N) -20°C +100°C (-4°F +212°F)
FPM (V) -10°C +180°C (+14°F +356°F)
EPDM (E) -40°C +150°C (-40°F +302°F)

Compatible
ISO 6150-C

rtc TYPE 452

ISO 6150-C / Coded Serie

Pneumatic



dn 6 mm

- i** **Advantage**
Self Venting Safety Type
- The system perfectly fits to the **ISO 4414, EN 983** safety Standards requirements.
 - Model to ISO 6150-C-10 and AFNOR: C-10 NF E 49-053
 - Safety feature: 2-stage disconnection
 - Coded type - Non-Interchangeable

25 bar (365 PSI)
15 bar (220 PSI) Connection / Disconnection

NBR (N) -20°C +100°C (-4°F +212°F)
FPM (V) -10°C +180°C (+14°F +356°F)
EPDM (E) -40°C +150°C (-40°F +302°F)

Compatible
ISO 6150-C

Available Codes





dn 11 mm - 19 mm

15 bar - 220 PSI

NBR (N) -20°C +100°C (-4°F +212°F)
 FPM (V) -10°C +180°C (+14°F +356°F)
 EPDM (E) -40°C +150°C (-40°F +302°F)

- i** **Advantage**
 Self Venting Safety Type
- The system perfectly fits to the **ISO 4414, EN 983** safety Standards.
 - Safety feature: 2-stage disconnection
 - Coded type (Non-Interchangeable) is also available.
- Option**
 - Stainless Steel

Water

rtc TYPE 453 & 454



Available Codes



dn 6 mm - 8 mm - 11 mm

12 - 16 bar (175 - 230 PSI)

NBR (N) -20°C +100°C (-4°F +212°F)
 FPM (V) -10°C +180°C (+14°F +356°F)
 EPDM (E) -40°C +150°C (-40°F +302°F)

- i** **Standard version**
 Stainless Steel
 Seals NBR (N)
Advantage
 Self Venting Safety Type
- The system perfectly fits to the **ISO 4414, EN 983** safety Standards requirements.
 - Safety feature: 2-stage disconnection

Compatible
 ISO 6150-C

Pneumatic

rtc TYPE 171
 ISO 6150-C



dn 6 mm - 8 mm

12 - 16 bar (175 - 230 PSI)

NBR (N) -20°C +100°C (-4°F +212°F)
 FPM (V) -10°C +180°C (+14°F +356°F)
 EPDM (E) -40°C +150°C (-40°F +302°F)

- i** **Standard version**
 Stainless Steel and Plastic Cover
 Seals NBR (N)
Advantage
 Self Venting Safety Type
- The system perfectly fits to the **ISO 4414, EN 983** safety Standards requirements.
 - Safety feature: 2-stage disconnection

Compatible
 ISO 6150-C

Pneumatic

rtc TYPE 172
 ISO 6150-C



dn 6 mm - 7 mm - 9 mm - 12 mm - 19 mm
 32 mm

30 - 40 bar (435 - 580 PSI) - Brass (MS) for gases
 10 - 30 bar (145 - 435 PSI) - Brass (MS) for liquids
 30 - 40 bar (435 - 580 PSI) - Steel (ST) for gases
 10 - 30 bar (145 - 435 PSI) - Steel (ST) for liquids

NBR (N) -20°C +100°C (-4°F +212°F)
 FPM (V) -10°C +180°C (+14°F +356°F)
 EPDM (E) -40°C +150°C (-40°F +302°F)

Compatible
 Walther UF Type

Water

Pneumatic

rtc TYPE 204
 Coded Connection



Available Codes

rtc TYPE 002

Pneumatic



dn 7.8 mm

Compatible
 rtc 463.08
 rtc 025
 rtc 026
 Rectus 25 & 26
 Cejn 320

Pressure 35 bar - 510 PSI

Temperature NBR (N) -20°C +100°C (-4°F +212°F)

rtc TYPE 003

Pneumatic



dn 5 mm

Standard version
 Brass Nickel Plated
 Seals NBR (N)
Option
 - Brass
 - Colour Coding

Pressure 35 bar - 510 PSI

Compatible
 rtc 021
 Rectus 21

Temperature NBR (N) -20°C +100°C (-4°F +212°F)
 FPM (V) -10°C +180°C (+14°F +356°F)

rtc TYPE 013

Pneumatic



dn 7.5 mm - 13 mm

Compatible
 Nitto Kohki
 Nitto Kohki
 Rectus
 Cejn
 Hi Cupla
 Hi Cupla 200
 13
 315

Pressure 35 bar - 510 PSI

Temperature NBR (N) -20°C +100°C (-4°F +212°F)

rtc TYPE 014

Pneumatic



dn 5 mm - 9.5 mm

Compatible
 rtc 014.06
 rtc 022
 rtc 462.06
 Rectus 14KA, 22KA
 Parker 50
 Aro 210
 Cejn 300
 Orion 44510

Pressure 35 bar - 510 PSI

Temperature NBR (N) -20°C +100°C (-4°F +212°F)

rtc 014.09
 rtc 462.09
 Rectus 40
 Aro 310
 Orion 44520, 44530



Pneumatic

rtc TYPE 017

dn 5 mm - 9.5 mm

Compatible
 Rectus 17KA - 68KA
 Schrader 1/4" / 3/8" Heavy Duty

35 bar - 510 PSI

NBR (N) -20°C +100°C (-4°F +212°F)
 FPM (V) -10°C +180°C (+14°F +356°F)



Pneumatic

rtc TYPE 019

dn 5.5 mm

Compatible
 Rectus 19KA
 PCL AC21, AC29, AC91

35 bar - 510 PSI

NBR (N) -20°C +100°C (-4°F +212°F)



Pneumatic

rtc TYPE 020

dn 2.7 mm

Compatible
 Rectus 20
 Rectus 20KB
 Walther 06-003

35 bar - 510 PSI

NBR (N) -20°C +100°C (-4°F +212°F)
 FPM (V) -10°C +180°C (+14°F +356°F)



Water Pneumatic

rtc TYPE 021

dn 5 mm

i Standard version
 Brass
 Seals NBR (N)
 Option
 - Brass Nickel Plated
 - Colour Coding

35 bar - 510 PSI

Compatible
 rtc 003
 Rectus 21

NBR (N) -20°C +100°C (-4°F +212°F)
 FPM (V) -10°C +180°C (+14°F +356°F)



rtc TYPE 022

Pneumatic



5.5 mm



Compatible

rtc	462.06
rtc	014.06
AMFLO	C38
ARO	210
Cejn	300
Foster	210
Parker	B53
Rectus	14 & 22



35 bar - 510 PSI



NBR (N) -20°C +100°C (-4°F +212°F)

rtc TYPE 023 ISO 6150-B-12

Pneumatic



5.5 mm



Compatible

US (Industrial) MIL-C-4109 1/4	
ISO 6150-B-12	
rtc	460.06
Hansen	1000
Cejn	310
Foster	3003
Parker	B23
Rectus	23 & 24



35 bar - 510 PSI



NBR (N) -20°C +100°C (-4°F +212°F)

rtc TYPE 025

Pneumatic



7.8 mm



Option

- Colour & Mechanical Coding



Compatible

rtc	463.08
rtc	002
rtc	026
Rectus	25 & 26
Rectus	25KB & 26KB
Cejn	320



35 bar - 510 PSI



NBR (N) -20°C +100°C (-4°F +212°F)
FPM (V) -10°C +180°C (+14°F +356°F)

rtc TYPE 026

Pneumatic



7.2 mm



Compatible

rtc	463.08
rtc	002
rtc	025
Rectus	25 & 26
Rectus	25KB & 26KB
Cejn	320



35 bar - 510 PSI



NBR (N) -20°C +100°C (-4°F +212°F)



dn 10.5 mm

 35 bar - 510 PSI

 NBR (N) -20°C +100°C (-4°F +212°F)
FPM (V) -10°C +180°C (+14°F +356°F)

 **Compatible**
Rectus 27
Rectus 27KB
Cejn 410
Tema 1700

Pneumatic

rtc TYPE 027



dn 8.5 mm

 35 bar - 510 PSI

 NBR (N) -20°C +100°C (-4°F +212°F)
FPM (V) -10°C +180°C (+14°F +356°F)
EPDM (E) -40°C +150°C (-40°F +302°F)

 **Compatible**
US (Industrial) MIL-C-4109 3/8
ISO 6150-B-15
rtc 460.08
Rectus 30KA
Cejn 430
Parker 25F

Pneumatic

rtc TYPE 030
ISO 6150-B-15



dn 6 mm - 10 mm - 13 mm

 35 bar - 510 PSI

 NBR (N) -20°C +100°C (-4°F +212°F)
FPM (V) -10°C +180°C (+14°F +356°F)

 **Compatible**
rtc 032.06
Rectus 31KA
Cejn 303
Tema 1300

rtc 032.10
Rectus 32KA
Cejn 408
Tema 1800

Pneumatic

rtc TYPE 032



dn 8 mm

 35 bar - 510 PSI

 NBR (N) -20°C +100°C (-4°F +212°F)
FPM (V) -10°C +180°C (+14°F +356°F)

 **Compatible**
rtc 468.08
Atlas Copco QIC10
Rectus 33

Pneumatic

rtc TYPE 033



rtc TYPE 035

Pneumatic



dn 7.8 mm

35 bar - 510 PSI

NBR (N) -20°C +100°C (-4°F +212°F)

i Advantages
 - Safety locking mechanism.
 - Breathing air applications.
 - To disconnect, the plug must first be pushed further into the coupling before it can be unlocked.

Compatible
 Rectus 95KS
 Cejn 344

rtc TYPE 036

Pneumatic



dn 7.8 mm

35 bar - 510 PSI

NBR (N) -20°C +100°C (-4°F +212°F)

i Advantages
 - Safety locking mechanism.
 - Breathing air applications.
 - To disconnect, the plug must first be pushed further into the coupling before it can be unlocked.

Compatible
 Rectus 96KS
 Cejn 342

rtc TYPE 037

ISO 6150-B-17 & ISO 6150-B-23

Pneumatic



dn 11 mm - 16 mm

35 bar - 510 PSI

NBR (N) -20°C +100°C (-4°F +212°F)

Compatible
 rtc 037.11
 US (Industrial) MIL-C-4109 1/2
 ISO 6150-B-17
 rtc 460.11
 Rectus 37KA
 Hansen 5000

rtc 037.16
 US (Industrial) MIL-C-4109 5/8
 ISO 6150-B-23

rtc TYPE 038

Pneumatic



dn 15 mm - 19 mm

35 bar - 510 PSI

NBR (N) -20°C +100°C (-4°F +212°F)

Compatible
 rtc 038.15
 Rectus 38 - 38KB
 Hansen 6000

rtc 038.19
 Rectus 39 - 39KB
 Hansen 7000



Pneumatic

rtc TYPE 055

dn 5.2 mm - 7 mm - 10.5 mm

Compatible
Imopac

35 bar - 510 PSI

NBR (N) -20°C +100°C (-4°F +212°F)



Pneumatic

rtc TYPE 058

dn 7.8 mm

i **Advantages**
 - Safety locking mechanism.
 - Breathing air applications.
 - To disconnect, the plug must first be pushed further into the coupling before it can be unlocked.

35 bar - 510 PSI

Compatible
 Rectus 25 KS
 Rectus 25 KD

NBR (N) -20°C +100°C (-4°F +212°F)



Pneumatic

rtc TYPE 133

dn 4 mm

i **Advantages**
 Panel mount on test units laboratory desks.
 Pneumatic automation control.

15 bar (217 PSI) - Brass (MS)
 250 bar (3626 PSI) - Stainless Steel (S6)

NBR (N) -20°C +100°C (-4°F +212°F)
 FPM (V) -10°C +180°C (+14°F +356°F)



Water

rtc TYPE 350

dn 4 mm - 6 mm

i **Advantages**
 Panel mount on test units laboratory desks.
 Pneumatic automation control.
 Medical clean room applications.

10 bar - 145 PSI

Compatible
 CPC LC
 CPC MC

NBR (N) -20°C +100°C (-4°F +212°F)
 FPM (V) -10°C +180°C (+14°F +356°F)
 EPDM (E) -40°C +150°C (-40°F +302°F)
 FMQ (FSN) -50°C +175°C (- 58°F +347°F)

New Design



rtc TYPE BC

Threadless Pressure Plug

- 1. Material: Brass
- 2. Material: Inner Part Stainless Steel - Edelstahl

 Compatible
Hasco Z 942



rtc TYPE BCO

Threadless Pressure Plug

- Material: Brass
- O-Ring: FPM (V) -10°C +180°C (+14°F +356°F)

 Compatible
EOC KN / 105



rtc TYPE PPR & PPK

Conical Thread Pressure Plug (DIN 906)

- Material: Brass
- Option: Stainless Steel
- Steel Zinc Plated



rtc TYPE PPG & PPM

Straight Thread Pressure Plug



rtc TYPE PPD

Pressure Plug with Copper Washer (DIN 908)

- Material: Brass
- Washer: Copper Ring



rtc TYPE PPO

Pressure Plug with O-Ring

- Material: Brass
- O-Ring: FPM (V) -10°C +180°C (+14°F +356°F)
- Option: Stainless Steel
- Aluminium



rtc TYPE SCN (PTFE & Hydraulic)

Crimping Hose Adapters with Female thread

- Material: Steel Zinc Plated (Inner Stainless Steel)
- Option: Stainless Steel



rtc TYPE MHN

Male Hose Nippel

- Material: Brass
- Option: Stainless Steel
- Steel Zinc Plated
- Brass Nickel Plated

Available in all hose profiles*



*Available Hose Profiles

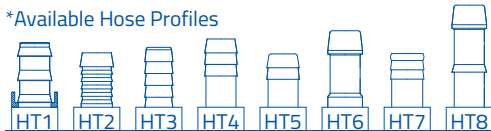

rtc TYPE FHN

Female Hose Nippel

- Material: Brass
- Option: Stainless Steel
- Steel Zinc Plated
- Brass Nickel Plated

Available in all hose profiles*



rtc TYPE FHNN

Swivel Female Hose Nippel

- Material: Brass
- Option: Stainless Steel
- Steel Zinc Plated
- Brass Nickel Plated

Available in all hose profiles*



rtc TYPE SPN

Swivel Hose Nippel

- Material: Steel Zinc Plated
- Option: Stainless Steel



rtc TYPE MRN

Swivel Hose Nippel

- Material: Steel Zinc Plated



rtc TYPE MMS

Swivel Hose Nippel

- Material: Steel Zinc Plated
- Option: Stainless Steel



rtc TYPE NOP

Pneumatic Hose Adapter with Nut

Material: Brass
 Plate: Nickel Plated - Verzinkt
 O-Ring: NBR (N) -20°C +100°C (-4°F +212°F)



rtc TYPE IQS

Pneumatic Push Fittings



rtc TYPE PU-Coil

PU Pneumatic Spiral Hose

Material: Polyurethan
 Colour: Blue, Red, Yellow

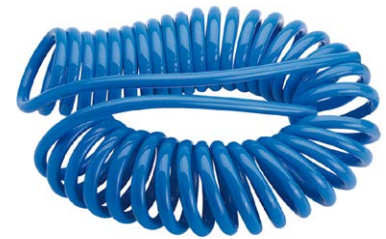

rtc TYPE HHN

Hose - Hose Nippel

Material: Brass
 Option: Stainless Steel
 Steel Zinc Plated
 Brass Nickel Plated
 Available in all hose profiles*



rtc TYPE SRM & SRG

Extension Hose Plugs with Male straight thread

Material: Brass



rtc TYPE PUN

Polyurethan Pneumatic Hose Roll

Material: Polyurethan
 Colour: Blue, Red, Yellow, Green, Clear



rtc TYPE MFN

Male - Female Thread Adapter

Material: Brass
 Option: Stainless Steel
 Steel Zinc Plated



rtc TYPE MMN

Male Thread Adapter with Inner Cone (DIN 3863)

Material: Brass
 Option: Stainless Steel
 Steel Zinc Plated



rtc TYPE EBFM

45° & 90° Male to Female Elbow

Material: Brass



rtc TYPE CPE

Two Ear Hose Clamp

Material: Steel Zinc Plated



rtc TYPE CPW2

Worm Drive Hose Clamp

Material: Steel Zinc Plated
 Band: Stainless Steel



rtc TYPE CPB

Hose Crimping Bush (For Low Pressure)

Material: Steel Zinc Plated



Accessories

rtc TYPE KVFM Mini Ball Valve - Female / Male



Material: Brass Nickel Plated

dn 1/4" - 3/8" - 1/2" - 3/4" - 1" - 1-1/4"

40 - 50 bar (580 - 725 PSI)

-20°C +150°C (-4°F +212°F)

rtc TYPE SVFM Standard Ball Valve - Female / Male

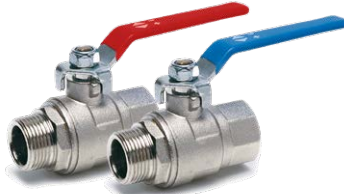

Material: Brass Nickel Plated

dn 1/4" - 3/8" - 1/2" - 3/4" - 1" - 1-1/4" - 1-1/2"

40 - 50 bar (580 - 725 PSI)

-20°C +150°C (-4°F +212°F)

rtc TYPE TVFM T Handle Ball Valve - Female / Male



Material: Brass Nickel Plated

dn 1/4" - 3/8" - 1/2" - 3/4"

40 - 50 bar (580 - 725 PSI)

-20°C +150°C (-4°F +212°F)

rtc TYPE KVFF Mini Ball Valve - Female / Female



Material: Brass Nickel Plated

dn 1/4" - 3/8" - 1/2" - 3/4" - 1" - 1-1/4"

40 - 50 bar (580 - 725 PSI)

-20°C +150°C (-4°F +212°F)

rtc TYPE SVFF Standard Ball Valve - Female / Female

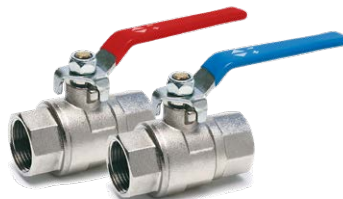

Material: Brass Nickel Plated

dn 1/4" - 3/8" - 1/2" - 3/4" - 1" - 1-1/4" - 1-1/2"

40 - 50 bar (580 - 725 PSI)

-20°C +150°C (-4°F +212°F)

rtc TYPE TVFF T Handle Ball Valve - Female / Female



Material: Brass Nickel Plated

dn 1/4" - 3/8" - 1/2" - 3/4"

40 - 50 bar (580 - 725 PSI)

-20°C +150°C (-4°F +212°F)

rtc TYPE 117 Brass Manifold

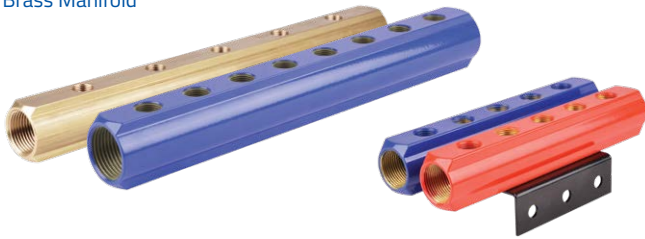

Inlet	Outlet
3/4"	1/4" & 3/8"
1"	1/4" & 3/8" & 1/2"
1-1/4"	3/8" & 1/2"

10 bar - 145 PSI

-20°C +250°C (-4°F +482°F)

rtc TYPE 118 5 Surfaced Aluminium Manifold



Inlet	Outlet
3/4"	1/4" & 3/8"
1"	1/4" & 3/8"
1-1/4"	1/4" & 3/8" & 1/2"
1-1/2"	1/4" & 3/8" & 1/2" & 3/4"
2"	3/8" & 1/2" & 3/4" & 1"

10 bar - 145 PSI

-20°C +250°C (-4°F +482°F)

rtc TYPE 119 3 Surfaced Stainless Steel Manifold



Inlet	Outlet
1"	1/4" & 3/8" & 1/2"
1-1/4"	1/4" & 3/8" & 1/2"
1-1/2"	1/4" & 3/8" & 1/2" & 3/4"

i Options
High port thread is shown on the picture.
- Low port thread,
- Twin profile (max. 2 Surfaced hole is available)

10 bar - 145 PSI

-20°C +400°C (-4°F +752°F)



Advantages

- Quick and easy installation
- Return of the ejector plate is assured
- Part ejection is assured
- Coupling is obtained in any position, disconnecting is made only after the ejector plate is fully returned.
- Fast acting, up to 30 stokes per minute.
- Can be used on all injection machines equipped with hydraulic or mechanical ejection
- Set-up time can be greatly reduced.
- Reduced noise on machines with mechanical knockouts
- Especially suited for injection machines that do not have easy access to the ejector plate.



Compatible - Max.Pull Force

rtc 092.16	1500 kg	Alba 300 Series
rtc 092.18	2400 kg	Alba 400 Series
rtc 092.25	3200 kg	Alba 500 Series

rtc 092.19	1500 kg	Pneumatic Series
rtc 092.36	6000 kg	Pneumatic Series
rtc 092.44	8000 kg	Pneumatic Series



*New Design / *Neues Design



6 mm



Cascade Water Junction

RTC Cascade Water Junctions can be ideally used for cooling plastics molds and die-cast dies where drilled waterlines through the block are not possible due to interference with ejector pins, sprue puller pins, etc.

The length of the tube can be changed.



16 bar (232 PSI)



FPM (V) -10°C +180°C (+14°F +356°F)

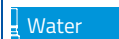

Water

rtc TYPE CSD Cascade Water Junction



Baffles

RTC Baffles are ideal for cooling plastics molds and die-cast dies where drilled waterlines through the block are not possible due to interference with ejector pins, sprue puller pins, etc.

The length and the material can be changed according to its useage area.

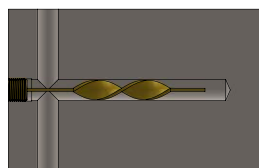
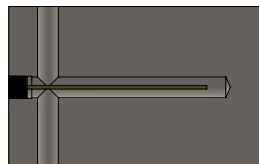

rtc TYPE SBM & TBM Straight & Turbo Baffles



Swivel Joints

The swivel joints of the ZT.GG series are designed to be mounted between a hose assembly and a rigid component of a machine in order to allow and compensate occasional rotations: the movement of the stem on his own axis prevents hose damages. They are used in every productive sector where there are means, equipments or plant with moving flexible hoses.



1/4" - 3/8" - 1/2" - 3/4" - 1 - 1.1/4" - 1.1/2"



Option
- Stainless Steel



NBR (N) -20°C + 100°C (-4°F + 212°F)
FPM (V) -20°C + 180°C (-4°F + 356°F)

rtc TYPE ZT.GG Swivel Joints



Hoses

Push to Connect - PTFE & Hydraulic

rtc TYPE PTFE Hose

Stainless Steel Braided PTFE Hose



- i** PTFE Hoses with Stainless Steel Braided
 - RTH - PTFE Stainless Steel Braided **Corrugated** Hose with **Fiber Reinforcement**
 - RCH - PTFE Stainless Steel Braided **Corrugated** Hose
 - RSH - PTFE Stainless Steel Braided **Straight** Hose
 - RIH - PTFE Stainless Steel Braided **Straight** Hose with **Fabric Cover** (Colours: **Red, Blue, Black**)
 - RFH - PTFE Stainless Steel Braided **Corrugated** Hose with **Fabric Cover** (Colours: **Red, Blue, Black**)
- ID** 6 mm - 8 mm - 10 mm - 12 mm - 16 mm - 19 mm - 25 mm
- Working Pressure** 24 bar - 348 PSI **Bursting Pressure** 72 bar - 1.044 PSI
- For Water** **For Air**
- rtc PTFE Hoses** -50°C +250°C (-58°F +482°F) -40°C +70°C (-40°F +194°F)

rtc TYPE HTI

High Temperature Hose Insulating Sleeve



- i** High Temperature Hose Insulating Sleeve
 - High temperature and flame resistant
 - Thermal insulation
 - Anti-fire and anti-aging
 - Protection against splashing metal sparks
 - Abrasion resistance, water, oil and acid proof and alkali resistant.
- ID** 15 mm - 20 mm - 22 mm - 25 mm - 30 mm - 35 mm
- Continuous** **Peak** **Resistance**
- 60°C +260°C (-76°F +500°F) (max 15 minutes) (max 20 seconds)
- 1050°C (1922°F) 1650°C (3002°F)

rtc TYPE LOCK Hose

Push to Connect - Clampless Hose



- i** Push to Connect (rtc LOCK) Type Hose
 - Tube:** EPDM Rubber Tube
 - Reinforcement:** Two textile spiral braid
 - Cover:** EPDM rubber cover
 - Application:** Water or air based fluids (Must **avoid** oil or fat)
 - Colours:** **Red, Blue, Black**
- ID** 6 mm - 10 mm - 12 mm - 16 mm - 19 mm - 25 mm
1/4" - 3/8" - 1/2" - 5/8" - 3/4" - 1"
- Working Pressure** 24 bar - 348 PSI **Bursting Pressure** 72 bar - 1.044 PSI
- For Water** **For Air**
- rtc LOCK 90S -40°C +90°C (-40°F +194°F) -40°C +70°C (-40°F +194°F)
- rtc LOCK 120S -40°C +120°C (-40°F +248°F) -40°C +90°C (-40°F +194°F)
- rtc LOCK 140S -40°C +140°C (-40°F +284°F) -40°C +120°C (-40°F +248°F)

rtc TYPE Stamina Hose

Hydraulic 2SN Hose



- i** Hydraulic 2SN Hose
 - Tube:** Special Rubber Tube (Hydraulic Oil, Mineral and Vegetable resistant)
 - Reinforcement:** 2 High tensile steel wire braid
 - Cover:** Special Rubber Tube (Oil, Abrasion and Weather resistant)
 - Application:** Medium-High Pressure Hydraulic Systems
- ID** 6 mm - 10 mm - 12 mm - 16 mm - 19 mm - 25 mm
1/4" - 3/8" - 1/2" - 5/8" - 3/4" - 1"
- 165 - 400 bar (2.393 - 5.800 PSI) - Working Pressure**
690 - 1.700 bar (10.005 - 24.650 PSI) - Bursting Pressure
- For Water** **For Air**
- rtc PTFE Hoses -50°C +250°C (-58°F +482°F) -40°C +70°C (-40°F +194°F)



dn 6 mm

10 bar - 145 PSI

NBR (N) -20°C +100°C (-4°F +212°F)
FPM (V) -10°C +180°C (+14°F +356°F)

i **Standard version**
Stainless Steel and Steel Zinc Plated
Advantage

Through its constant concern for operator safety, RTC has developed five models of blowgun combining Safety, Low Noise Level and Efficiency to meet the specific requirements of all applications.

Pneumatic

rtc TYPE 456
Air Blow Gun



dn 1 mm - 100 mm

0 - 16 bar - 0 - 232 PSI

NBR (N) -20°C +100°C (-4°F +212°F)
FPM (V) -10°C +180°C (+14°F +356°F)

i **Engine Test Couplings**

Designed to meet customer specifications, the versatile 930 couplings can be mated to all types of hose and pipe connections in the automotive industry assembled on the engine.

RTC designs customised solutions for each application according to the connection profile, type of fluids and environment.

The best solution to test all engine circuits before the final assembly.

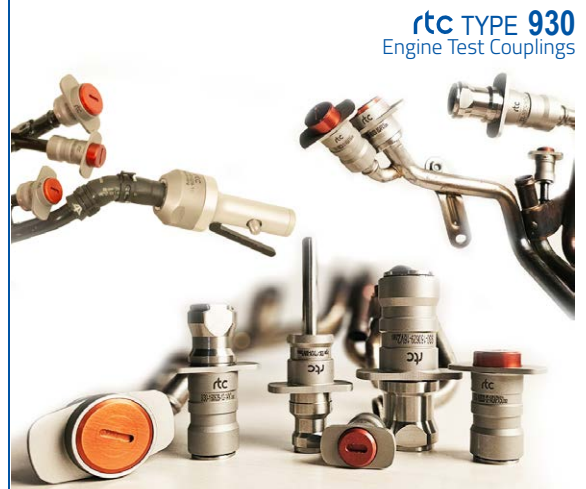

rtc TYPE 930
Engine Test Couplings

i **Universal Hose Assembly Tool**

Push to Connect fittings assembly tool is great solution for any size of hose up to 1" by easy adjustment.

Straight 45° or 90° hose tail can be used.

Compact, light, robust and mobile and easy to operate.

rtc TYPE HFT
Hose Assembly Tool



- Electricity **NOT** required
- Works with **AIR**
- Increases the **PRODUCTIVITY**
- Controls **LEAKAGE** on the mold
- Compact and ergonomic **DESIGN**
- **USER FRIENDLY** control panel
- **EASY** to move around and operate
- Cleans with **IMPACT**
- **CLEANS, PROTECTS** and **POSTPONES**
- Works in **HARMONY** with mold and components

Technical Details

- Required Air Pressure : 4-6 bars
- Hose Length : 2 meters
- Tank Volumes : 3 tanks x 30 liters
- Max.Pump Flow Rate : 50 lt/min

- Benötigt **KEINEN** Strom
- Arbeitet mit **DRUCKLUFT**
- Steigert die **PRODUKTIVITÄT**
- Überwacht die **UNDICHTIGKEITEN** am Werkzeug
- Kompaktes und ergonomisches **DESIGN**
- **BENUTZERFREUNDLICHES** Bedienfeld
- Einfacher Transport und Einsatz
- Reinigt durch Druckstöße
- **REINIGT, SPÜLT** und **KONSERVIERT**
- Arbeitet im selben Umfeld des Werkzeugs und deren Peripherie

Technische Details

- Benötigte Druckluft : 4-6 bar
- Schlauchlänge : 2 meter
- Behälter : 3 Behälter x 30 Liter
- Max.Pumpen Durchfluss : 50 lt/min

rtc TYPE MMC
Mobile Mold Cleaner



rtc TYPE M090
European Profile

Water



Circuits - Kreislauf

3 ↔ 3 | 4 ↔ 4 | 5 ↔ 5 | 6 ↔ 6 | 8 ↔ 8 | 10 ↔ 10 | 12 ↔ 12

rtc TYPE M099
International Profile

Water

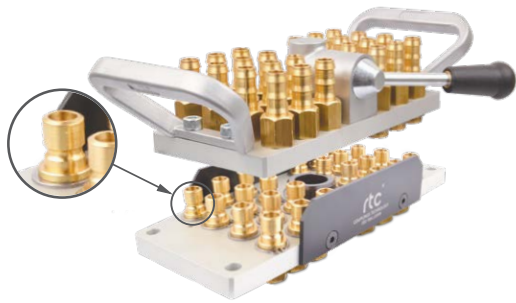

Circuits - Kreislauf

3 ↔ 3 | 4 ↔ 4 | 5 ↔ 5 | 6 ↔ 6 | 8 ↔ 8 | 10 ↔ 10 | 12 ↔ 12

rtc TYPE M101
French Profile

Water



Circuits - Kreislauf

3 ↔ 3 | 4 ↔ 4 | 5 ↔ 5 | 6 ↔ 6 | 8 ↔ 8 | 10 ↔ 10 | 12 ↔ 12

rtc TYPE M116
High Temperature

Chemical Hydraulic



High Temperature

New Design



Circuits - Kreislauf

3 ↔ 3 | 6 ↔ 6



dn 6 mm - 9 mm - 13 mm

16 bar - 232 PSI

FPM (V) -10°C +180°C (+14°F +356°F)
EPDM (E) -40°C +150°C (-40°F +302°F)
High Temp (HT) -20°C +230°C (-4°F +446°F)

- i** Standard version
Brass
Seals FPM (V)
Option
- Safety Lock
- Stainless Steel
- Alu Die Casted Plate
- Block Plate
- Colour coding (Red, Blue,...)
- Mechanical Coding

↔ Connections
6 / 8 / 10 / 12 / 16 / 20 / 24



dn 6 mm - 9 mm - 15 mm

16 bar - 232 PSI

FPM (V) -10°C +180°C (+14°F +356°F)
EPDM (E) -40°C +150°C (-40°F +302°F)
High Temp (HT) -20°C +230°C (-4°F +446°F)

- i** Standard version
Brass
Seals FPM (V)
Option
- Safety Lock
- Stainless Steel
- Alu Die Casted Plate
- Block Plate
- Colour coding (Red, Blue,...)
- Mechanical Coding

↔ Connections
6 / 8 / 10 / 12 / 16 / 20 / 24



dn 6 mm - 9 mm - 10 mm - 12 mm - 16 mm

16 bar - 232 PSI

FPM (V) -10°C +180°C (+14°F +356°F)
EPDM (E) -40°C +150°C (-40°F +302°F)
High Temp (HT) -20°C +230°C (-4°F +446°F)

- i** Standard version
Brass
Seals FPM (V)
Option
- Safety Lock
- Stainless Steel
- Alu Die Casted Plate
- Block Plate
- Colour coding (Red, Blue,...)
- Mechanical Coding

↔ Connections
6 / 8 / 10 / 12 / 16 / 20 / 24



dn 9 mm - 12 mm

16 bar - 232 PSI

FPM (V) -10°C +180°C (+14°F +356°F)
FFKM (W) 0°C +325°C (+32°F +617°F)

- i** Standard version
Stainless Steel
Seals FPM (V)
Option
- Safety Lock
- Colour coding (Red, Blue,...)
- Mechanical Coding

↔ Connections
6 / 12

Thermal Management Multi-Couplings



dn 9 mm - 12 mm

i Standard version
Brass
Seals FPM (V)
Option
- Colour coding (Red, Blue)

Pressure 16 bar - 232 PSI

Connections
6 / 12 / 18

Temperature
FPM (V) -10°C +180°C (+14°F +356°F)
EPDM (E) -40°C +150°C (-40°F +302°F)
High Temp (HT) -20°C +230°C (-4°F +446°F)

Water

rtc TYPE **M150**
Flatface



Circuits - Kreislauf
3 ↔ 3 | 6 ↔ 6 | 9 ↔ 9



dn 6 mm - 8 mm - 10 mm - 12 mm - 16 mm

i Standard version
Brass and Stainless Steel
Seals FPM (V)
Option
- Safety lock
- Stainless Steel
- Adapter Assembly Plate
- Block Plate
- Mechanical Coding
- Colour coding (Red, Blue)

Pressure 16 bar - 232 PSI

Connections
6 / 8 / 10 / 12 / 16 / 20 / 24

Temperature
FPM (V) -10°C +180°C (+14°F +356°F)
EPDM (E) -40°C +150°C (-40°F +302°F)
High Temp (HT) -20°C +230°C (-4°F +446°F)

Water

rtc TYPE **M152**
Flatface

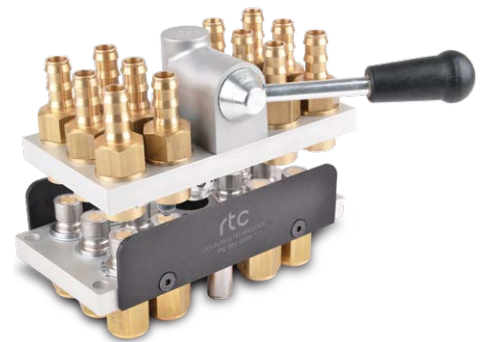

Circuits - Kreislauf
3 ↔ 3 | 4 ↔ 4 | 5 ↔ 5 | 6 ↔ 6 | 8 ↔ 8 | 10 ↔ 10 | 12 ↔ 12



dn 9 mm - 12 mm

i Standard version
Brass and Stainless Steel
Seals FPM (V)
Option
- Safety lock
- Stainless Steel
- Adapter Assembly Plate
- Block Plate
- Mechanical Coding
- Colour coding (Red, Blue)

Pressure 16 bar - 232 PSI

Connections
6 / 12 / 18 / 20

Temperature
FPM (V) -10°C +180°C (+14°F +356°F)
EPDM (E) -40°C +150°C (-40°F +302°F)
High Temp (HT) -20°C +230°C (-4°F +446°F)

Water

rtc TYPE **M153**
French Profile Flatface



Circuits - Kreislauf
3 ↔ 3 | 6 ↔ 6 | 9 ↔ 9 | 10 ↔ 10

dn 3/8"
12 mm

i Advantage
Control of each circuit
Material
Tubes: PA 6 with 30% fiberglass
O-Ring: EPDM (In contact water)
Regulating Taps: Brass
Option
- Female Thread
- Hose Connection
- Easy to Maintenance

Pressure
8 bar - 116 PSI (at 40°C - 104°F)
7 bar - 101.5 PSI (at 60°C - 140°F)
5 bar - 72.5 PSI (at 80°C - 176°F)
4 bar - 58 PSI (at 90°C - 194°F)

Connections
2 / 4 / 6 / 8 / 10 / 12 / 14 / 16 / 18 / 20 / 22 / 24

Water

rtc TYPE **WFR**
Water Flow Regulator



Circuits - Kreislauf
1 ↔ 1 | 2 ↔ 2 | 3 ↔ 3 | 4 ↔ 4 | 5 ↔ 5 | 6 ↔ 6 | 7 ↔ 7
8 ↔ 8 | 9 ↔ 9 | 10 ↔ 10 | 11 ↔ 11 | 12 ↔ 12

rtc TYPE M103 Residual Pressure Multi-Coupling



Hydraulic
New Design

Circuits - Kreislauf
1 ↔ 1 | 2 ↔ 2 | 3 ↔ 3 | 4 ↔ 4



11 mm



200 bar - 2.900 PSI



NBR (N) -20°C +100°C (-4°F +212°F)
FPM (V) -10°C +180°C (+14°F +356°F)



Advantage
Special valve design for Residual Pressure Connection
Suitable for hydraulic core pulls application
Option
- Safety Lock
- Colour coding (Red, Blue,...)
- Mechanical Coding



Connections
2 / 4 / 6 / 8

rtc TYPE M104



Hydraulic

Circuits - Kreislauf
1 ↔ 1 | 2 ↔ 2 | 3 ↔ 3 | 4 ↔ 4



8 mm
10 mm (High-Flow Type)



200 bar - 2.900 PSI



NBR (N) -20°C +100°C (-4°F +212°F)
FPM (V) -10°C +180°C (+14°F +356°F)



Advantage
Suitable for hydraulic core pulls application
Option
- Safety Lock
- Colour coding (Red, Blue,...)
- Mechanical Coding



Connections
2 / 4 / 6 / 8

rtc TYPE M115



Hydraulic

Circuits - Kreislauf
2 ↔ 2 | 3 ↔ 3 | 4 ↔ 4 | 5 ↔ 5 | 6 ↔ 6 | 7 ↔ 7 | 8 ↔ 8



3 mm - 5 mm



100 bar - 1.450 PSI



NBR (N) -20°C +100°C (-4°F +212°F)
FPM (V) -10°C +180°C (+14°F +356°F)



Advantage
Suitable for hydraulic hot runners connections
Option
- Safety Lock
- Colour coding (Red, Blue,...)
- Mechanical Coding



Connections
2 / 4 / 6 / 8 / 10 / 12 / 14 / 16

rtc TYPE M072



Hydraulic

New Design

Circuits - Kreislauf
2 ↔ 2 | 3 ↔ 3 | 4 ↔ 4 | 5 ↔ 5 | 6 ↔ 6



6 mm - 10 mm - 12 mm - 16 mm



200 bar - 2.900 PSI



NBR (N) -20°C +100°C (-4°F +212°F)
FPM (V) -10°C +180°C (+14°F +356°F)



Advantage
ISO 16028 Plug Profile
Option
- Safety Lock
- Colour coding (Red, Blue)

Connections
4 / 6 / 8 / 10 / 12



Electrical

rtc TYPE EC Electrical Connectors



d

- Ø 1.5
- Ø 2
- Ø 3
- Ø 5
- Ø 6
- Ø 8
- Ø 11

A

- 2 - 24 A
- 12 - 24 A
- 34 - 45 A
- 60 - 80 A
- 80 - 110 A
- 150 - 200 A
- 200 - 260 A

V

- 25 - 250 V
- 25 - 250 V
- 250 - 440 V
- 250 - 630 V
- 250 - 630 V
- 250 - 630 V
- 250 - 830 V

i

Using Areas
Signal (BUS)
Hybrid
Power
High Current



NBR (N) -30°C +100°C (-22°F +212°F)
Silicone (SIL) -40°C +150°C (-40°F +302°F)
Chloroprene (CP) -40°C +100°C (-40°F +212°F)



dn

2 mm - 4 mm - 6 mm - 8 mm

i

Customised Mini-Con

Mini-Con (Pneumatic Multi Connector) is efficient and very simple to operate.

Main advantage of the connector is, it can be able to fix up to 24 different pneumatic tubing with no effort.

Because of its compact design Mini-Con takes a minimum space.

Mainly using areas; robot control systems, machinery, compressed air.

Pneumatic

rtc TYPE M303 MiniCon Connector



rtc TYPE Customized Design Custom Designed Multi Coupling Plate

CUSTOMIZED DESIGN CUSTOMIZED SOLUTIONS

THINK.

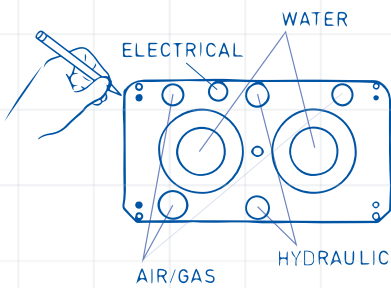

HIGH TEMPERATURE?
HIGH PRESSURE?
HIGH FLOW RATE?
HIGH VOLTAGE?

NO PROBLEM!

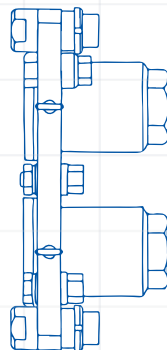

DESIGN.

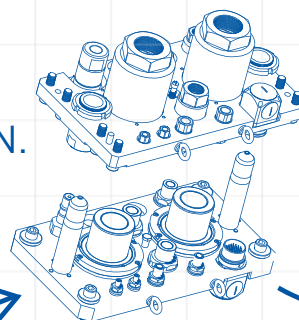

FINAL PRODUCT.

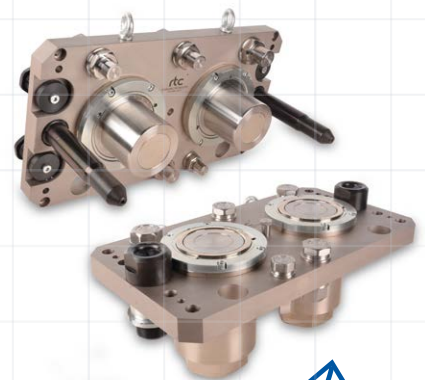

CONTROL **YOUR** FLOW.

MODERN. SAFE & RELIABLE.

Technical Specifications

- 6 – 72 cooling circuits
- 1 1/4" Inlet and return
- 1/2" cooling circuit connections
- Measuring range 1 – 60 l/min
- PT1000 temperature sensors
- Temperature range 5°C to 180°C
- Pressure range max. 8 bar
- IO-Link technology

Control unit & Visualization

- Screen resolution 1024 x 600 Pixel
- Resistive 10" touchscreen
- 64GB memory size
- Simple and intuitive user interface
- Storage of individual tool data records
- Logging of warning messages
- Possibility to monitor the entire production at any workstation (requires network connection)
- Integrated USB and Ethernet interfaces

Optional

- Machine connection via OPC UA
- Connection to external databases (SQL, ...)
- Stainless steel display housing for wall mounting
- High temperature **up to 180°C**
- On-site assembly service



SIMPLE - INTUITIVE - SMART ENGINEERING

Flow Sensor

- State-of-the-art double ultrasonic flow sensor
- Contactless measurement
- Maintenance free, no machine downtime
- Integrated display with status LED
- No risk of contamination, pressure loss or leaks



SIMPLE PLUG IN. READY.

Let yourself be inspired by the easy expandability of the Huracan system. Unpack, plug in, done!

Completely without time-consuming programming and wiring. The system immediately detects each additional HRC collector. Up to 12 HRC Pro can be connected to each other for monitoring 72 circuits with a single HMI.

ULTRASONIC FLOW MEASUREMENT.



STAY CONNECTED.



SMART. DOWN TO THE LAST DETAIL.

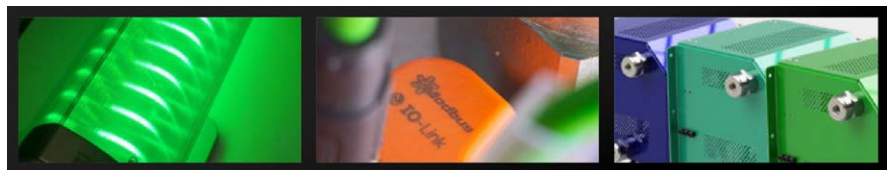

Thanks to its mobile application, Huracan Flow Control enables you to monitor and control your flows from anywhere with your login and password-inside your plant or outside with any internet connection.

Notes

GLOBAL PRESENCE – INTELLIGENT SOLUTIONS! MEET US ALL OVER THE WORLD

www.rtc-tec.com
www.rtc-couplings.com



RTC TEC Bağlantı Elemanları AŞ
Headquarters

IDOSB, Kadife Caddesi, No:2, 34956
Tuzla / İstanbul / TÜRKİYE
Tel: +90 216 593 47 82 - Fax: +90 216 593 47 85
sales@rtc-tec.com



RTC TEC Germany GmbH
European Headquarters

Daimlerstraße 10, 73037
Göppingen / GERMANY
Tel: +49 7161 98796-50 - Fax: +49 7161 98779
mail@rtc-couplings.com



RTC Austria austria@rtc-tec.com



RTC BeNeLux benelux@rtc-tec.com



RTC Bulgaria bulgaria@rtc-tec.com



RTC Czechia czechia@rtc-tec.com



RTC Denmark denmark@rtc-tec.com



RTC Finland finland@rtc-tec.com



RTC France france@rtc-tec.com



RTC Hungary hungary@rtc-tec.com



RTC Italy italy@rtc-tec.com



RTC Norway norway@rtc-tec.com



RTC Poland poland@rtc-tec.com



RTC Portugal portugal@rtc-tec.com



RTC Romania romania@rtc-tec.com



RTC Slovakia slovakia@rtc-tec.com



RTC Slovenia slovenia@rtc-tec.com



RTC Spain spain@rtc-tec.com



RTC Sweden sweden@rtc-tec.com



RTC Switzerland switzerland@rtc-tec.com



RTC UK uk@rtc-tec.com



RTC USA usa@rtc-tec.com



RTC Canada canada@rtc-tec.com



RTC Mexico mexico@rtc-tec.com



RTC Argentina argentina@rtc-tec.com



RTC Brasil brasil@rtc-tec.com



RTC Colombia colombia@rtc-tec.com



RTC Australia australia@rtc-tec.com



RTC China china@rtc-tec.com



RTC Japan japan@rtc-tec.com



RTC India india@rtc-tec.com



RTC New Zealand newzealand@rtc-tec.com



RTC Singapore singapore@rtc-tec.com



RTC South Korea southkorea@rtc-tec.com



RTC Thailand thailand@rtc-tec.com



RTC Taiwan taiwan@rtc-tec.com



RTC Vietnam vietnam@rtc-tec.com



RTC Morocco morocco@rtc-tec.com



RTC South Africa southafrica@rtc-tec.com